

NU Series
 NU2200
 cylindrical roller
 bearing-**NU2216**

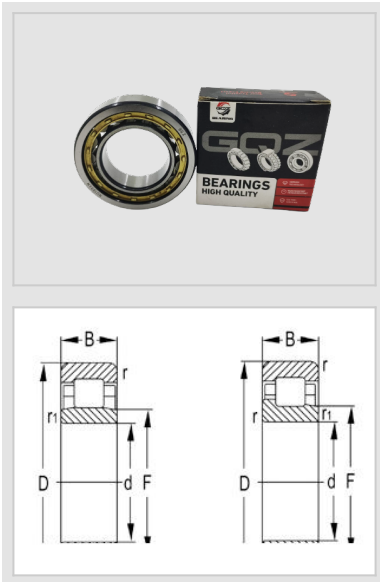

WUXI GUANGQIANG BEARING TRADE CO.,LTD



Designation	NU2216
Principal Dimensions(mm)	
d	80
D	140
B	33
rs min	2
rs1 min	2
Basic Load Ratings(KN)	
Dynamic(Cr)	147
Static(Cor)	186
Limited Speed(rpm)	
Grease	4400
Oil	5100
Weight (kg)	1.93

GQZ bearings wholesale high quality NU2200 Cylindrical Roller Bearing

NU2200 bearings are a kind of spherical ball bearings with the following characteristics:

Dimensional parameters: the dimensional parameters of NU2200 bearings include an outer diameter of 30mm, an inner diameter of 10mm, and a thickness of 14mm. these dimensional parameters determine the scope of application and mounting method of the bearings.

Application range: Due to their moderate size, NU2200 bearings are suitable for application scenarios that require less space and light loads. They can find use in a variety of mechanical devices, such as simple rotary applications, low-speed operation of mechanical equipment and so on.

Alignment performance: as part of the spherical ball bearings, NU2200 bearings have a certain degree of alignment ability, which can adapt to slight shaft bending or axial misalignment, and reduce the wear and failure of mechanical components.

Rated Load: The bearing is rated at 7450N dynamic load and 1590N static load, these figures reflect the bearing's load carrying capacity under specific conditions.

Brand and series: NU2200 bearings belong to the spherical ball bearing series under the NACHI brand, this series also includes other models, such as 2200 bearings, which may differ slightly in size and performance.

Wuxi Guangqiang Bearing Trade Co.,Ltd-Tel:86-510-82601571-
 Email:gq@gqbearing.com,shary@gqbearing.com-http://www.bearing-asia.com